

Ages 14+

Potensic[®]



A20

Operations Guide

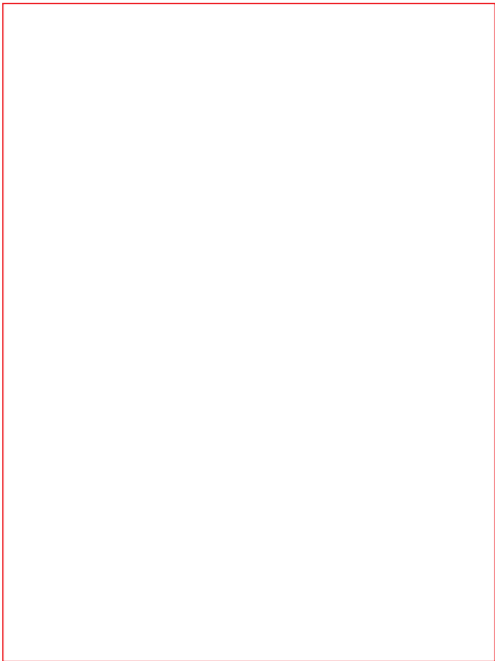

Catalogue

Overview of drone and transmitter	3
Parts loading and unloading	8
Precautions before flying	10
Flying procedures	11
Function Introductions.....	17
Assembly Parts list	20
Troubleshooting	22

Overview of drone and transmitter

Drone

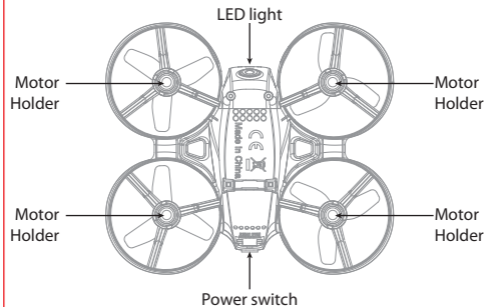
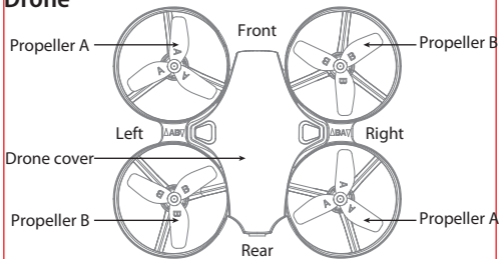

Main Parameter

Drone size	90x80x32mm	Flying time	5~6 mins
Weight of drone	25.8g	The main motor	0615x4
Propeller diameter	Ø32mm	Remote control mode	2.4Ghz
The drone battery	3.7Vx180mAh	Flying distance	10~15 m
The charging time of the drone battery		40 mins	

Exploded View

NO.	Name	NO.	Name
1	Drone cover	7	Counterclockwise Motor
2	Receiver Board	8	LED light
3	Propeller A	9	Light shade
4	Propeller B	10	Battery cover
5	Forward motor	11	Drone bottom
6	Rehearsal motor	12	Drone battery

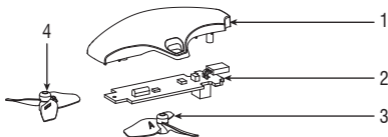

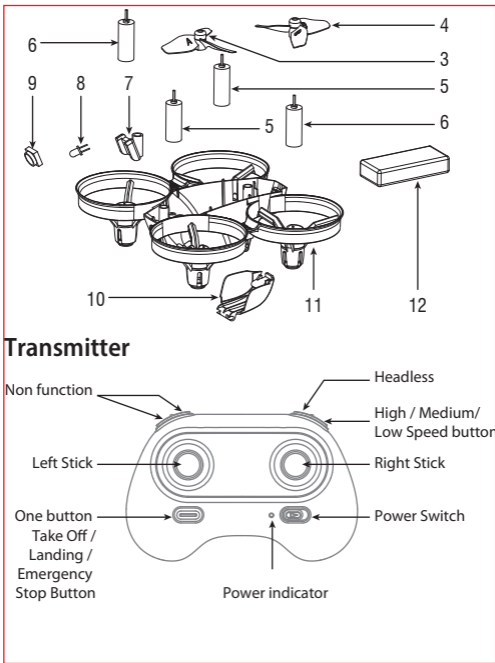

Trimmer mode button (Press down)

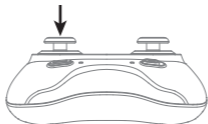

Brief Introduction for Button Functions

Left Stick	Move the Stick to forward / backward / left / right to fly the drone up / down / turn left / turn right.
Right Stick	Move the Stick to forward / backward / left / right to fly the drone forward / backward / left / right.
Power Switch	Pull right the power switch key to power on the transmitter, power off when returns.
Headless Mode	Press the key to enter the headless mode; Press again to exist.
High / Medium/ Low Speed Button	Press the key to switch to High /Medium/ Low Speed.
Take Off / Landing /Emergency Stop Button	After frequency pairing, press once and the drone will take off automatically. Press again and the drone will land automatically. Press and hold the button for more than 1 second for an emergency landing. The drone propellers will stop and land.
Trimmer Mode Button	Press this button and move the right stick to the required trimmer direction, then it will adjust the direction accordingly. Release the stick to end trimmer mode.

Transmitter Battery installation

Open the battery cover of the transmitter, insert 3 AAA batteries following the polarity indicators (Picture below, battery is not included) and then close it.

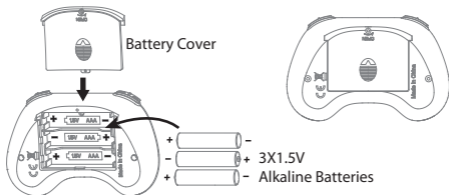

Notice:

1. Make sure the electrodes are correct.
2. Do not mix new with old batteries.
3. Do not mix different kinds of batteries.
4. Do not charge the non rechargeable battery.

Parts installation

Charging Instruction for Drone Battery

1. Connect the drone battery with USB cable first and then choose one of the chargers as below shown to connect with USB plug.
2. The red USB indicator light keeps bright when charging and the light turns green when fully charged.

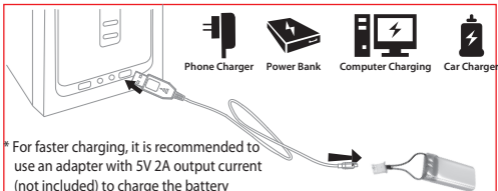

Li-Po Battery Disposal & Recycling



Wasted Lithium-Polymer batteries must not be placed with household trash. Please contact local environmental or waste agency or the supplier of your model or your nearest Li-Po battery recycling center.



Assemble/Disassemble the Propellers

To disassemble, gently lift the propeller upward.(Picture 1)

To install the propeller, align and snap on the propeller blade to the motor.(Picture 2)

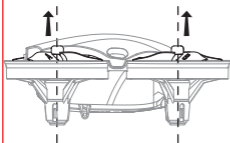

Picture 1

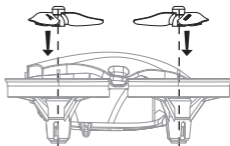

Picture 2

Diagram of battery loading and unloading

Buckle down the battery cover, put the battery into the drone, and then buckle up the battery cover (Picture 3/4).

Picture 3

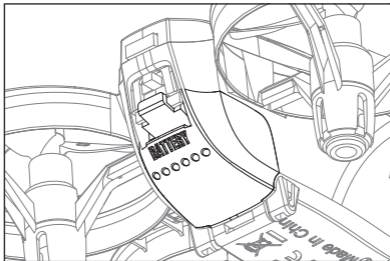

Picture 4

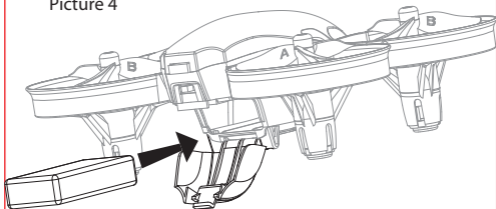

Precautions before flying

1. Make sure the transmitter and the battery of the drone are fully charged.
2. Before starting, please confirm that the left stick of the transmitter is in the middle position.
3. Please follow the correct steps to turn on the drone/transmitter. Before flight, turn on transmitter and then the the drone. After flight, turn off the drone and then transmitter. Turning ON/OFF incorrectly may cause the drone to lose control.
4. Make sure to correctly install the battery, motor, etc.
5. Improper operation may cause drone crash, which may cause a motor defect, prevent you from flying, and other issues. Please go to the local distributor to buy new parts for replacement so that the drone will return to its best

Flight steps

Syncing Frequencies

Turn on the drone. The drone body lights will flash rapidly at first. When it flashes slowly, indicating entering frequency pairing.



It must be placed on a surface!

Turn on the transmitter and the power indicator light on it flashes rapidly.

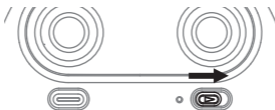

Pull the left stick to the lowest position and then release. The power indicator on transmitter will turn a solid color and the transmitter will beep, indicating successful frequency pairing



Take Off

After calibration successfully, press this button, the drone will fly up and keep flying at an altitude of approximately 1.2 meters automatically.

Landing

Press it to land the drone automatically. (In this mode, DO NOT touch the left stick, otherwise it might not work).

Emergency Landing

In an emergency situation, such as if it is about to hit people or obstacles, press the Take Off/ Landing / Emergency Stop Button and hold it for more than 1 second. The propellers will stop immediately and the drone will fall.

Tip: Do not activate this function unless in emergency situation.
Because the drone will fall when the motors stop working.

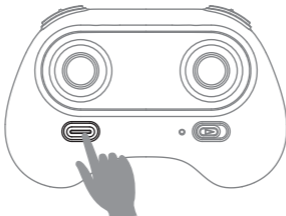

Calibration (This action is used in case of flight abnormality)

Push the right stick as picture shown after successful frequency pairing(DO NOT push the left stick before it) . Please loose it when the drone front body light flash 3 times and turn a solid color , indicating that calibration is completed.

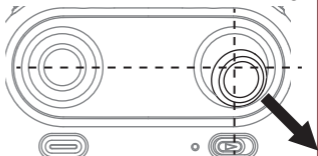

Tips: Crashing the drone may cause the connection to fail, making the drone hard to control. If this occurs, try repairing and calibration. It must be placed on a surface!

Unlocking/locking the motor

Unlock the motor:

Move the left stick and right stick at the same time 45 degrees inward.

Lock the motor:

When the motor is working, it could be used to stop the motor urgently (Move the left stick and right stick at the same time 45 degrees inward).

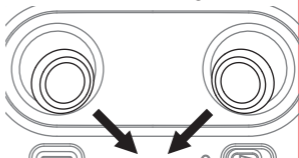

Flight Control

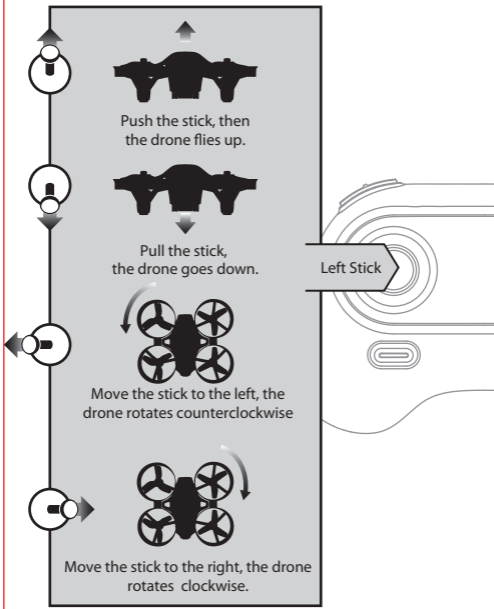

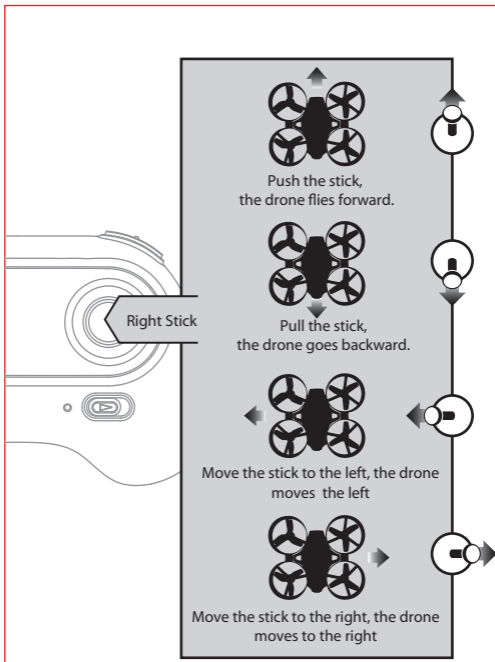

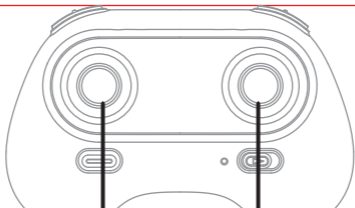

Forward and backward trimmer

When flying, if the drone tilts forward, press down the trimmer button, and push the right stick backwards. Otherwise push forwards.

Left/Right Rotates Trimmer

When flying, if the drone head rotates to the left, press the trimmer button, and push left stick to right. Otherwise push to the left.

Left/Right Tilts Trimmer

When flying, if the drone tilts to the left, press the trimmer button, and push the right stick to the right. Otherwise push to the left.

Functions Mode

Altitude Hold Mode

Intelligent flight control system calculates the hovering position, makes it easier for beginners to control. Release the stick, the drone will keep hovering, capturing clear aerial photos & videos.

Note: If there's propeller or motor is damaged, the constant height function will not work. Due to atmospheric pressure instability or unsuitable weather, the high altitude hold function will not work either.

High / Medium/Low Speed Mode Switch

1. Low Speed Mode(Mode 1)

It's suitable for the beginners to operate in calm weather, with no breeze.

2. Medium speed Mode(Mode 2)

It's suitable for those practicing (hobbyists) to operate, with or without breeze.

3. High Speed Mode(Mode 3)

It's suitable for the professionals in most outdoor wind conditions.

Note: The default setting is Medium Speed.

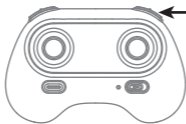

High / Medium/Low Speed mode

Headless Mode

The default setting is NOT Headless Mode.

Under headless mode, the users can operate the drone without worrying about the orientation (left is left and right is right all the time, regardless of where your drone is pointing at). Headless Mode is designed for beginners, users who fly the drone in daylight or at far distances, or those with difficulty identifying the drone orientation.

You can activate the headless mode function before taking off or in flight. Flying under headless mode, your drone direction should be aligned with you. DO NOT change the direction of your transmitter, keep it flying in front of you at all the times. (See below picture).

WARNING: THE DRONE SHOULD BE IN FRONT OF YOUR TRANSMITTER BEFORE ENTERING THIS MODEL. OR THE DRONE MIGHT LOSE CONTROL OR FLY AWAY.

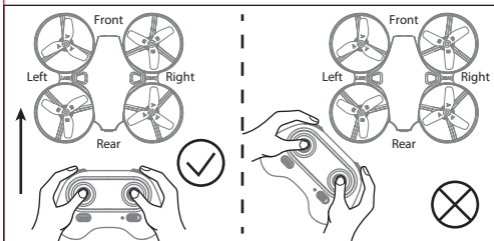

* Press headless mode button to activate the function, at this time the LED light on the rear of drone keeps shiny for three times and stops for 1s; To exit the Headless Mode, press the button again, at this time the LED light on the rear of drone will turn a solid color.

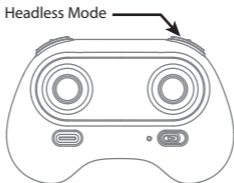

Low Battery Alarm

When the transmitter has a low battery, the transmitter will beep to remind the user to land the drone as soon as possible and replace the batteries. Or the drone might be out of control.

When the drone has a low battery, the LED light on the rear of drone will keep shiny for once and stop for 1 second. Then please land the drone as soon as possible and replace the battery.

Out of Range Alarm

When the drone is out of range or almost at the max remote control distance, the LED light on the rear of drone will keep shiny for twice and stop for 1 second. Then please fly the drone back to suitable range as soon as possible or it may be out of control.

Spare Parts (Sold separately)

For convenience, the spare parts are listed for you to choose, which can be purchased from the local seller.



A20-01
Drone Cover



A20-02
Drone Bottom



A20-03
Propeller A



A20-04
Propeller B



A20-05
Lampshade



A20-06
Pressure Parts



A20-07
Receiver Board



A20-08
LED Light



A20-09
Drone Battery



A20-10
USB Cable



A20-11
Clockwise Motor
(Red and Blue wire)



A20-12
Counterclockwise
Motor
(Black and White wire)



A20-13
Transmitter

Important Notice

Our company's products are improving all the time, design and specifications are subject to change without notice.

All the information in this manual has been carefully checked to ensure accuracy, if any printing errors, our company reserve the final interpretation right.

Troubleshooting Guide

No.	Problem	Problem Cause	Solution
1	The transmitter indicator light is off	1. Low battery.	1. Replace the transmitter battery.
		2. The battery positive pole and negative pole are in reverse order.	2. Install the battery in accordance with the user manual.
		3. Poor Connection	3. Clean the dirt between the battery and the battery slice.
2	Fail to pair the drone with transmitter	1. Indicator light is off.	1. The same as above 1.2.3.
		2. There is interfering signal nearby.	2. Turn off and turn on the drone and transmitter again.
		3. Mis-operation.	3. Operate the drone step by step in accordance with the user manual.
		4. The electronic component is damaged for frequent crash.	4. To buy spare parts from local seller and replace damaged parts.
3	The drone is under-powered or can not fly.	1. The propeller deformed seriously.	1. Replace the propeller.
		2. Low battery.	2. Recharge the drone battery.
		3. Incorrect installation of propeller.	3. Install the propeller in accordance with the user manual.

4	The drone could not hover and tilts to one side.	<ol style="list-style-type: none">1. The propeller deformed seriously.2. The motor holder deformed.3. The gyro did not reset after violent crash.4. The motor is damaged.	<ol style="list-style-type: none">1. Replace propeller.2. Replace the motor holder.3. Put the drone on the flat ground for about 10s or restart the the drone to calibrate again.4. Replace motor.
5	The drone indicator light is off.	<ol style="list-style-type: none">1. Low battery.2. The battery is expired or over discharge protection.	<ol style="list-style-type: none">1. Recharge the drone battery.2. Buy a new battery from local seller to replace the battery or charge the battery in accordance with the use manual.

FCC Note

This equipment has been tested and found to comply with the limits. These limits are designed to provide reasonable protection against harmful interference in a residential installation. This equipment generates uses and can radiate radio frequency energy and, if not installed and used in accordance with the instructions, may cause harmful interference to radio communications. However, there is no guarantee that interference will not occur in a particular installation.

If this equipment does cause harmful interference to radio or television reception, which can be determined by turning the equipment off and on, the user is encouraged to try to correct the interference by one or more of the following measures:

- Reorient or relocate the receiving antenna.
- Increase the separation between the equipment and receiver.
- Connect the equipment into an outlet on a circuit different from that to which the receiver is connected.

WARNING: Changes or modifications not expressly approved by the party responsible for compliance could void the user's authority to operate the equipment.

FCC Notice

The equipment may generate or use radio frequency energy. Changes unless the modifications are expressly approved in the instruction manual. Modifications not authorized by the manufacturer may void user's authority to operate this device.

This device complies with Part 15 of the FCC Rules. Operation is subject to the following two conditions:

- (1) This device may not cause harmful interference.
- (2) This device must accept any interference received, including interference that may cause undesired operation.



MADE IN CHINA



www.ipotensic.com